

# 0.175 mm pitch ultra-low profile FPC Back-lock Connector

RoHS2

## FF57 Series 【Upper Contact】

第一电子工业株式会社

### OUTLINE

The FF57 series ultra-low profile FPC LIF connector has a market leading height of only 0.5mm with a depth of just 3.0mm.

The cable lock mechanism provides maximum FPC circuit retention and alignment of the material.

DDK's FF57 LIF 0.175mm connector mates with an FPC circuit of 0.12mm thick.

The upper contact is utilized as the electrical contact for the FPC material.

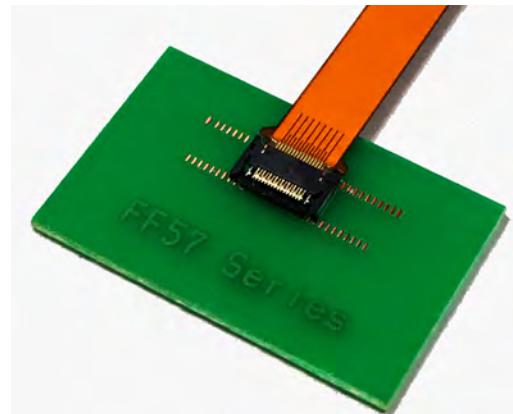

### FEATURES

- DDK's original cam-type "Back-lock" system ensures a reliable connection and continued retention from inadvertent upward pulling of the FPC.
- The FF57 FPC LIF connector has a pitch of 0.175mm and a mounting height of 0.5mm.
- DDK's cable lock mechanism provides positive retention of the FPC.
- Back-lock structure ensures retention from inadvertent from upward pulling of the FPC.
- The upper contact is used for electrical contact with the FPC circuit.
- Connectors are delivered unlocked, so the lock lever does not need to be opened before operation.
- Supplied with emboss tape for automatic mounting.
- Nickel barrier prevents solder wicking.
- Halogen Free
- The housing and lock lever are made of heat-resistant resin making the FPC connector compatible with lead-free reflow soldering.

Note: ※ Please do not close the lock lever without inserting the FPC.

※ Since the cable lock tabs electrically conductive on both ends, please do not use the cable lock tabs as ground tabs.

### APPLICATIONS

LCD Back-light module, Touch Panel, Accessory module

### SPECIFICATIONS

Rated Voltage	50V AC (r.m.s.)
Rated Current	0.2A / Contact
Dielectric Withstand Voltage	200V AC(r.m.s.) /1 minute
Insulation Resistance	50 M $\Omega$ min. at 250V DC
Contact Resistance	80m $\Omega$ max.

### MATERIAL/FINISH



Item	Material / Finish
Contact	Copper Alloy / Au (Flash) over Ni
Housing	LCP Resin (UL94V-0) / Black
Lock Lever	PPS Resin (UL94V-0) / Black

© Specifications and/or dimensions in this catalog are subject to change without notice.

Please verify the latest specifications with our drawings.



▶ 0.175mm pitch FPC LIF connector

◆ Dimensions  
Even number of contact

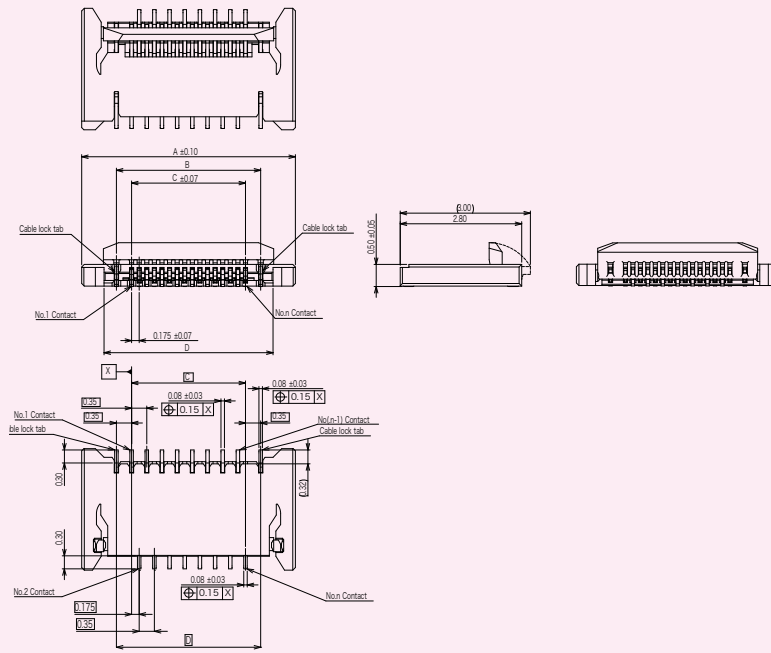

◆ Recommended P.C.B. Lay out

Shall be located zig zag from No.1

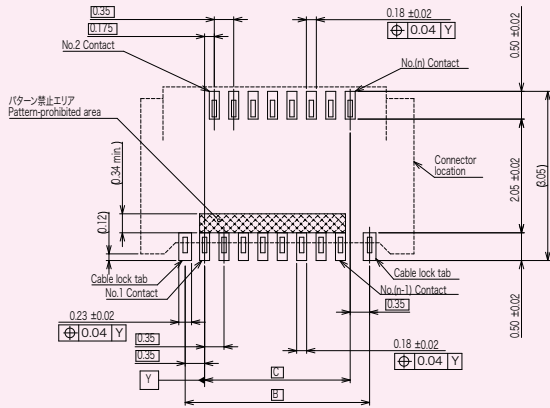

◆ Applicable FPC Dimensions

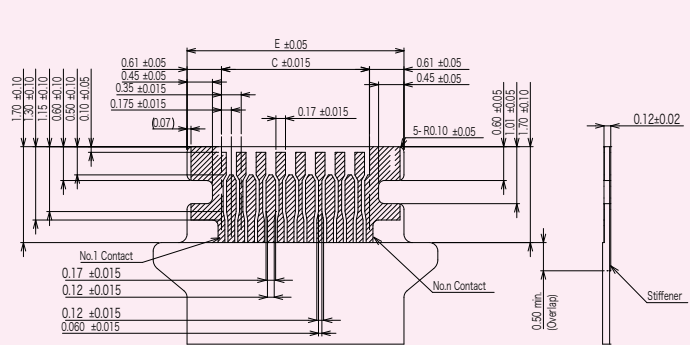

Table-1

Part Number	Number of Contact	A	B	C	D	E
FF57-16A-R21A-B-3H	16	4.925	3.325	2.625	3.895	3.845

© Specifications and/or dimensions in this catalog are subject to change without notice.  
Please verify the latest specifications with our drawings.

▶ Packing Specifications

■ Reel Dimensions

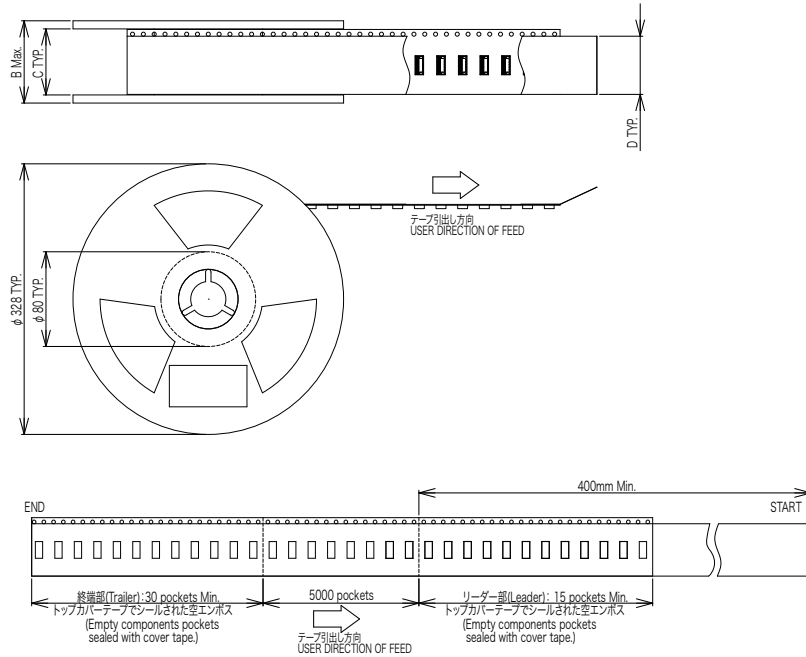

■ Emboss Tape Dimensions

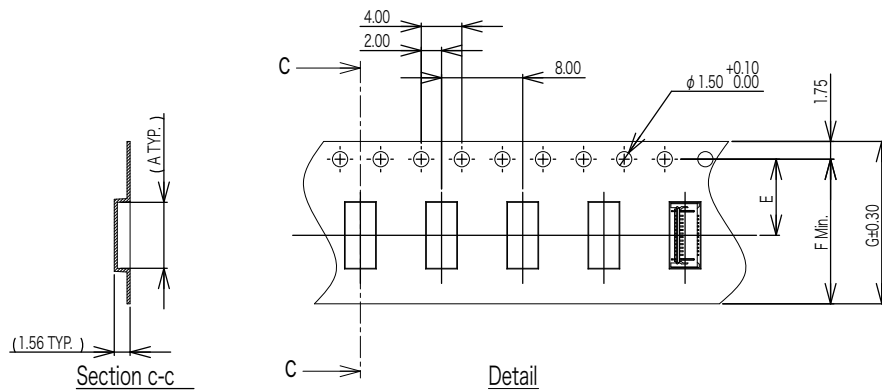

Part Number	Number of Contact	A	B	C	D	E	F	G
FF57-16A-R21A-B-3H	16	5.08	22.4	16.4	13.5	7.5	14.3	16.0

■ Package Quantity : 5,000pcs./Reel

© Specifications and/or dimensions in this catalog are subject to change without notice.  
Please verify the latest specifications with our drawings.

## ▶ Operating Instruction and Cautions

### 1. Connector mounting Instruction

• Connectors are delivered with the lock lever opened.  
You do not have to operate the lock lever before inserting FPC.  
( picture ①)

Lock lever is opened when delivery.

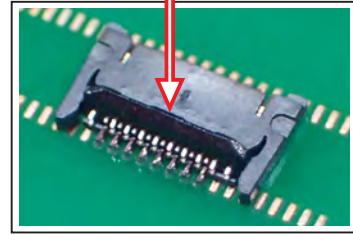

picture ①

• Please do not re-flow with the lock lever in the closed condition.

• Please do not close the lock lever without inserting FPC.  
Otherwise, the contact gap will become narrower and FPC insertion force will rise.

• Please do not load from the top of the lock lever. (figure ①)  
And please do not load toward the opposite direction of the lock lever. (figure ②)  
Otherwise, the lock lever may be broken or contacts may be deformed.

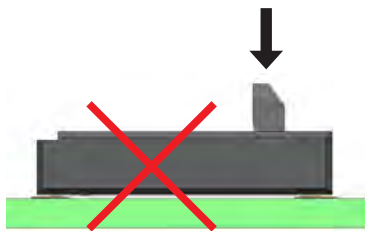

figure ①

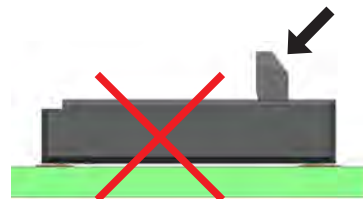

figure ②

• Please do not insert finger nail into the entry as it may damage the connector (figure ③)

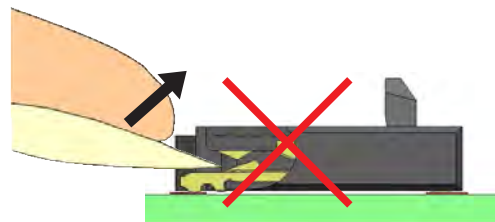

figure ③

▶ Operating Instruction and Cautions

Cable lock tabs conduct to both ends of contacts.  
 Please do not ground the cable lock tab pad on the mounting board. (figure ④)

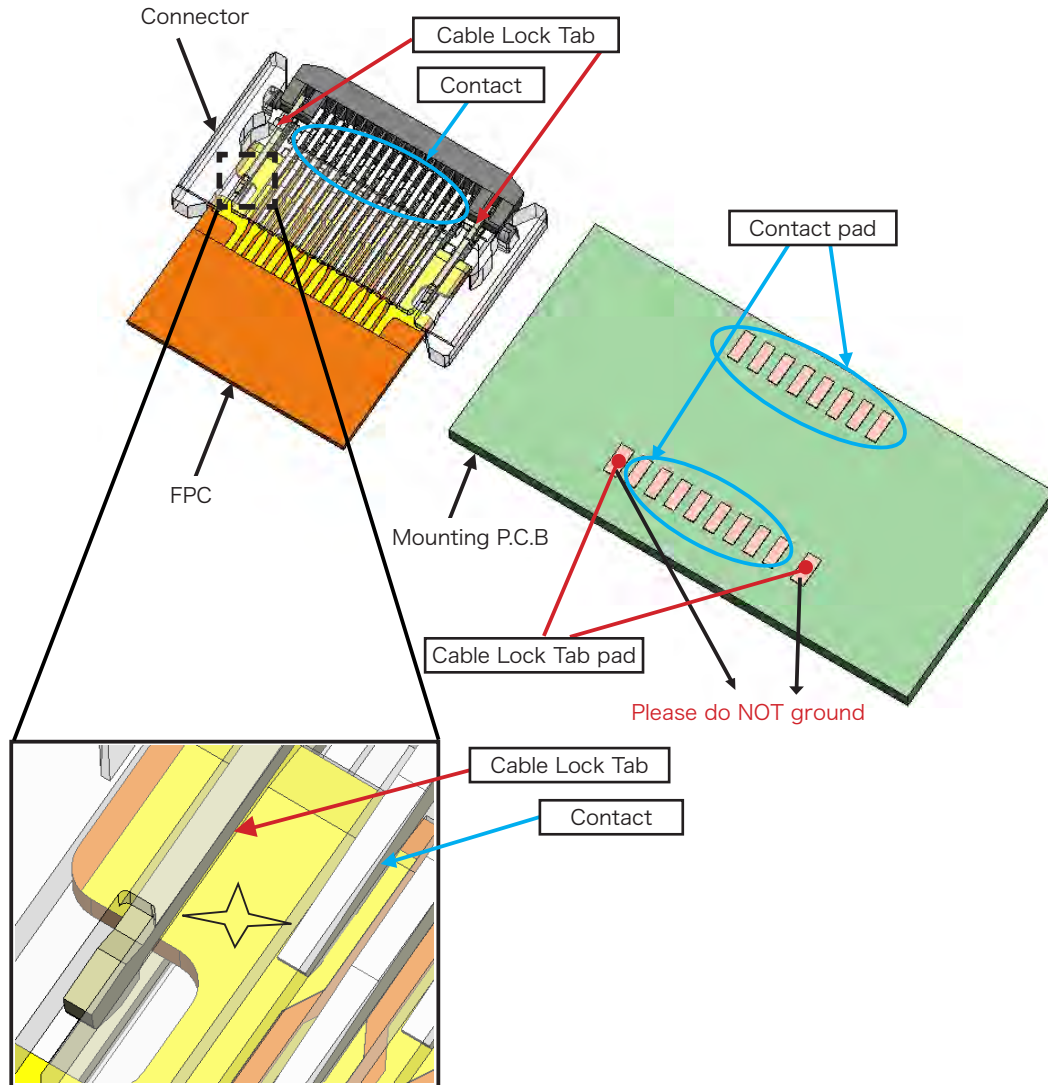
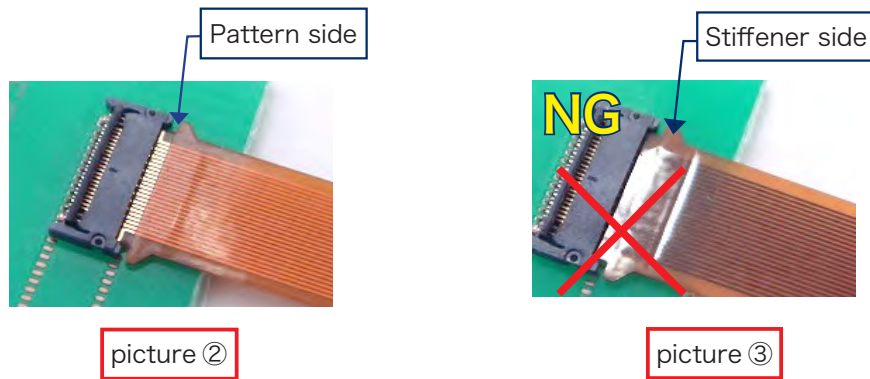

figure ④

▶ Operating Instruction and Cautions

## 2. FPC Insertion

- Please insert the FPC with the pattern side up.(correct: picture ② , wrong : picture ③)
- Please insert the FPC straight into the connector.  
Due to the semi-retaining mechanism, some insertion force is necessary when inserting FPC.  
FPC insertion is completed when the edges of the FPC are ouching connector frange.( picture ⑤)



## 3. Correct FPC Insertion Position

- The frange position enables a visual verification of the mating position.(figure ⑤) .  
It prevents shallow and diagonal insertion. ( picture ⑥、 ⑦)

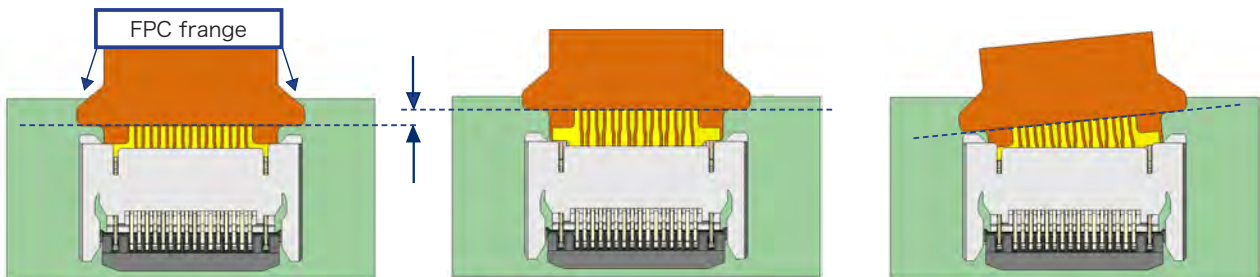

figure ⑤ : normal insersion

figure ⑥ : Shallow insertion

figure ⑦ : Diagonal insertion

- If cable lock tabs catch the FPC correctly, FPC patterns are not dislocated from contacts.

## ▶ Operating Instruction and Cautions

### 4. Closing Lock Lever

- Please rotate down the lock lever until firmly closed.(picture ④ )
- Please do not load excessive force on the housing.(picture ⑤ )

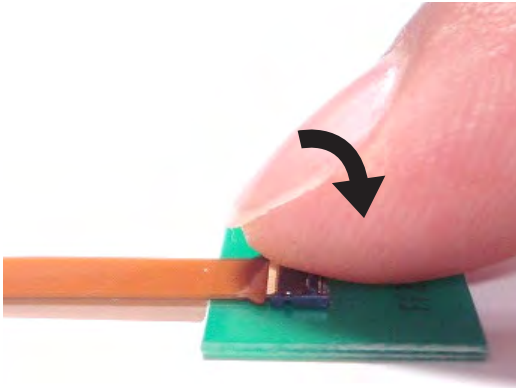

picture ④

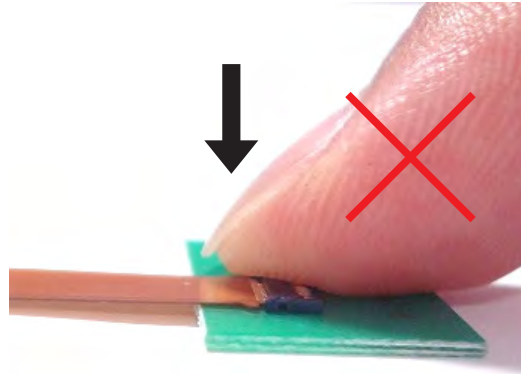

picture ⑤

- Please do not close the lock lever by tip of finger nail. (picture ⑥ )
- Please hold the lock lever at least half width of it. (picture ⑦ )

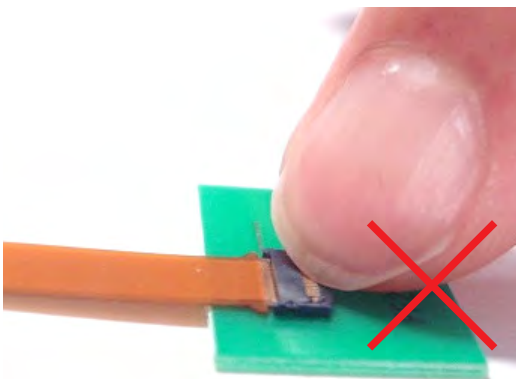

picture ⑥

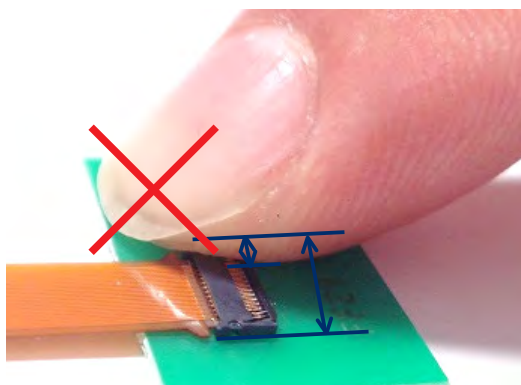

picture ⑦



## ▶ Operating Instruction and Cautions

### 5. Removing FPC

- Please lift the lock lever by flipping up in the direction of arrow.(picture ⑧ )
- Please do not load excessive force on the lock lever.(picture ⑨ )

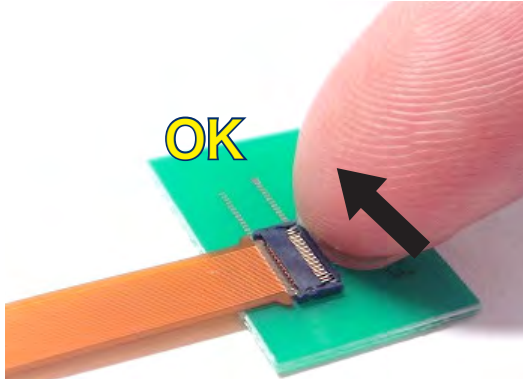

picture ⑧

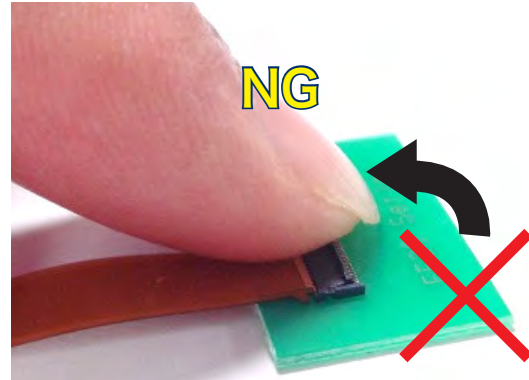

picture ⑨

### 6. Others

- In case of hand soldering, please do not heap excessive solder on the contact tails. (above terminal 0.05mm max.) (figure ⑧)

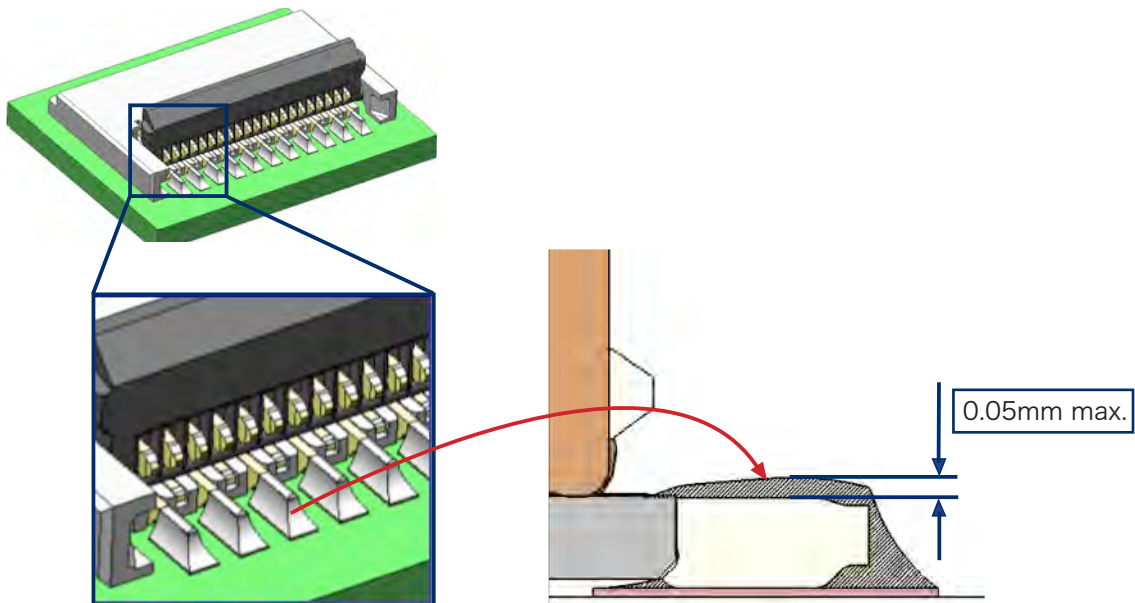

figure ⑧

### 7. ESD(Electrostatic Discharge)

This connector does not protect the circuit from ESD.

### 8. Disposal of connector

Please dispose the connector as industrial waste.